

# ALTEZZA TOP L240

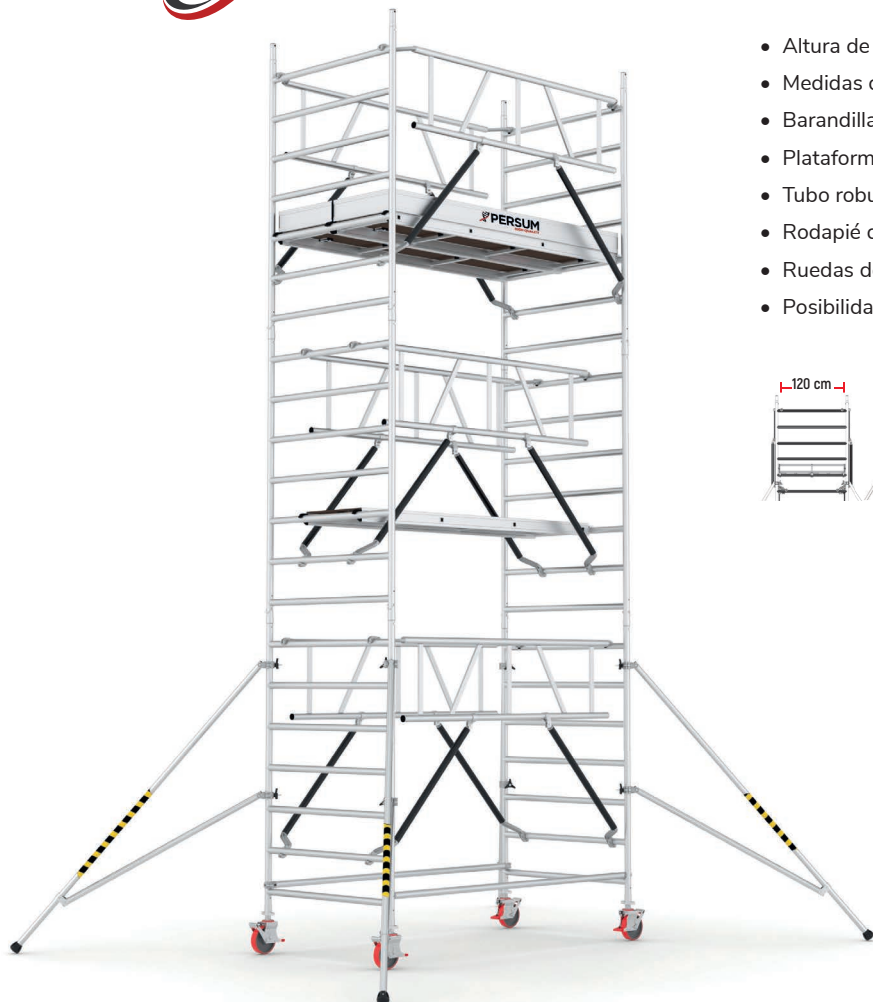

CLASE 3



## TRABAJOS PROFESIONALES DE USO INTENSIVO

- Altura de trabajo aproximada desde 4,30 m hasta 13,60 m.
- Medidas del andamio 135x255 cm.
- Barandillas **Flash-Safe**, reduciendo el tiempo de montaje un 30%.
- Plataformas de madera **Plywood** antideslizante de 240 cm.
- Tubo robusto de 50 mm de diámetro y 1,8 mm de espesor.
- Rodapié de aluminio, rápido y fácil montaje.
- Ruedas de 200 mm de diámetro con sistema de doble freno.
- Posibilidad de trabajar dos personas.

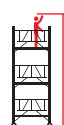
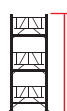
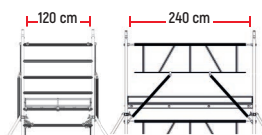

120x240 cm

		m.	m.	m.	cm.	cm.	kg
L430	14H0442	2,3	3,73	4,3	255x135	518x398	158
L520	14H0443	3,2	4,64	5,2	255x135	518x398	165
L640	14H0444	4,4	5,84	6,4	255x135	518x398	213
L730	14H0445	5,3	6,74	7,3	255x135	518x398	220
L850	14H0446	6,5	7,94	8,5	255x135	518x398	268
L940	14H0447	7,4	8,85	9,4	255x135	518x398	275
L1060	14H0448	8,6	10,05	10,6	255x135	518x398	324
L1150	14H0449	9,5	10,96	11,5	255x135	518x398	331
L1270	14H0450	10,7	12,16	12,7	255x135	518x398	379
L1360	14H0451	11,6	13,06	13,6	255x135	518x398	386



# CONFIGURACIÓN

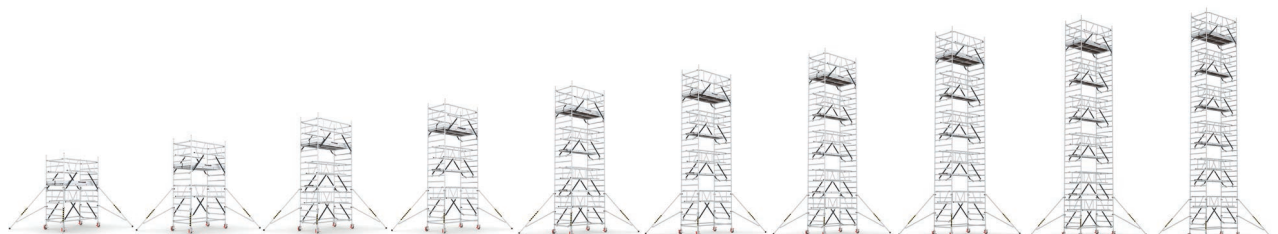
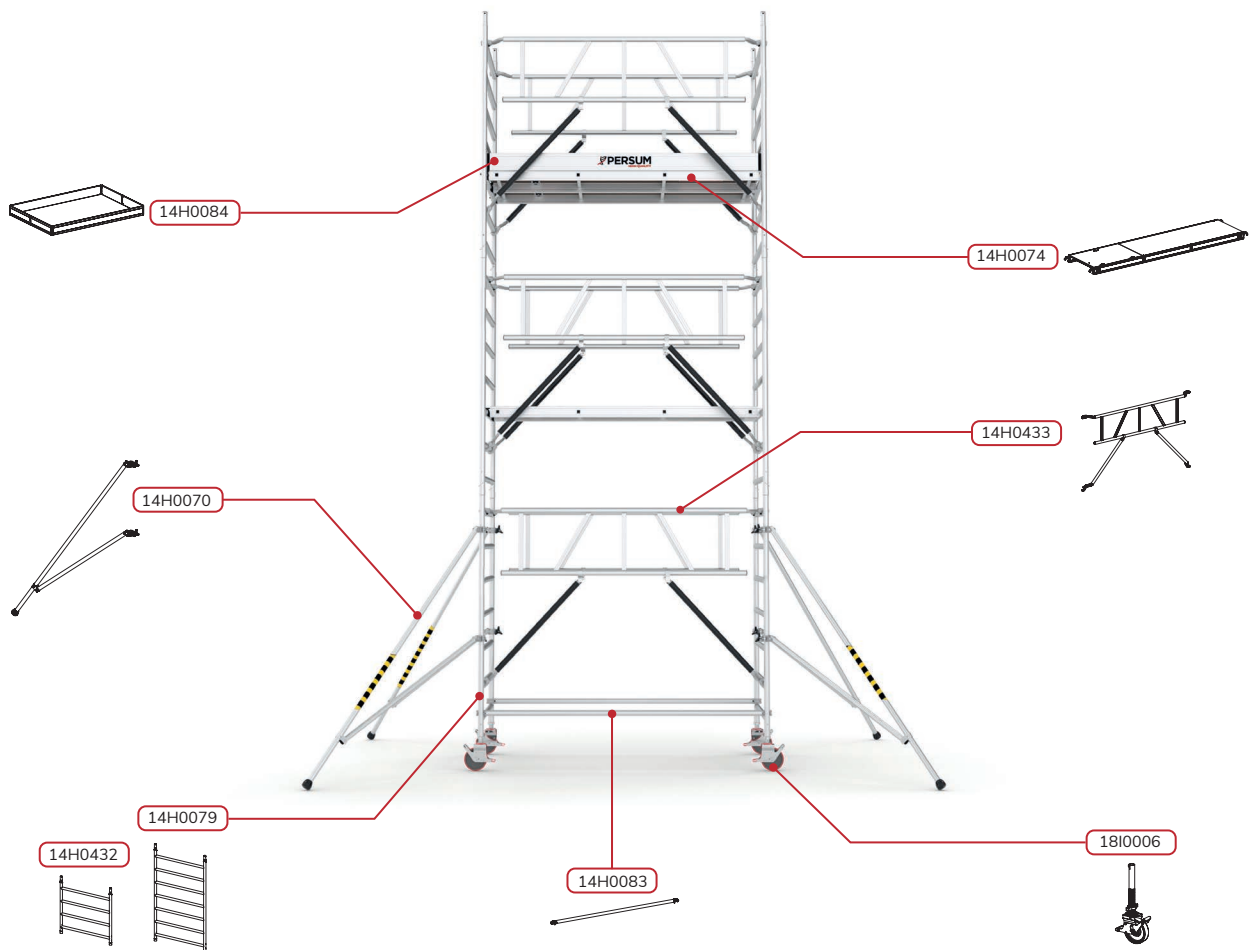

	L430	L520	L640	L730	L850	L940	L1060	L1150	L1270	L1360
18I0006	4	4	4	4	4	4	4	4	4	4
14H0432	2	-	2	-	2	-	2	-	2	-
14H0079	2	4	4	6	6	8	8	10	10	12
14H0433	4	4	6	6	8	8	10	10	12	12
14H0083	2	2	2	2	2	2	2	2	2	2
14H0070	4	4	4	4	4	4	4	4	4	4
14H0074	2	2	3	3	4	4	5	5	6	6
14H0084	1	1	1	1	1	1	1	1	1	1



# ALTEZZA TOP L 180



CLASE 3



## TRABAJOS PROFESIONALES DE USO INTENSIVO

- Altura de trabajo aproximada desde 4,30 m hasta 13,60 m.
- Medidas del andamio 135x196 cm.
- Barandillas **Flash-Safe**, reduciendo el tiempo de montaje un 30%.
- Plataformas de madera **Plywood** antideslizante de 180 cm.
- Tubo robusto de 50 mm de diámetro y 1,8 mm de espesor.
- Rodapié de aluminio, rápido y fácil montaje.
- Ruedas de 200 mm de diámetro con sistema de doble freno.
- Posibilidad de trabajar dos personas.

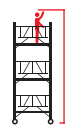
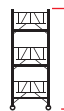
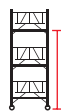
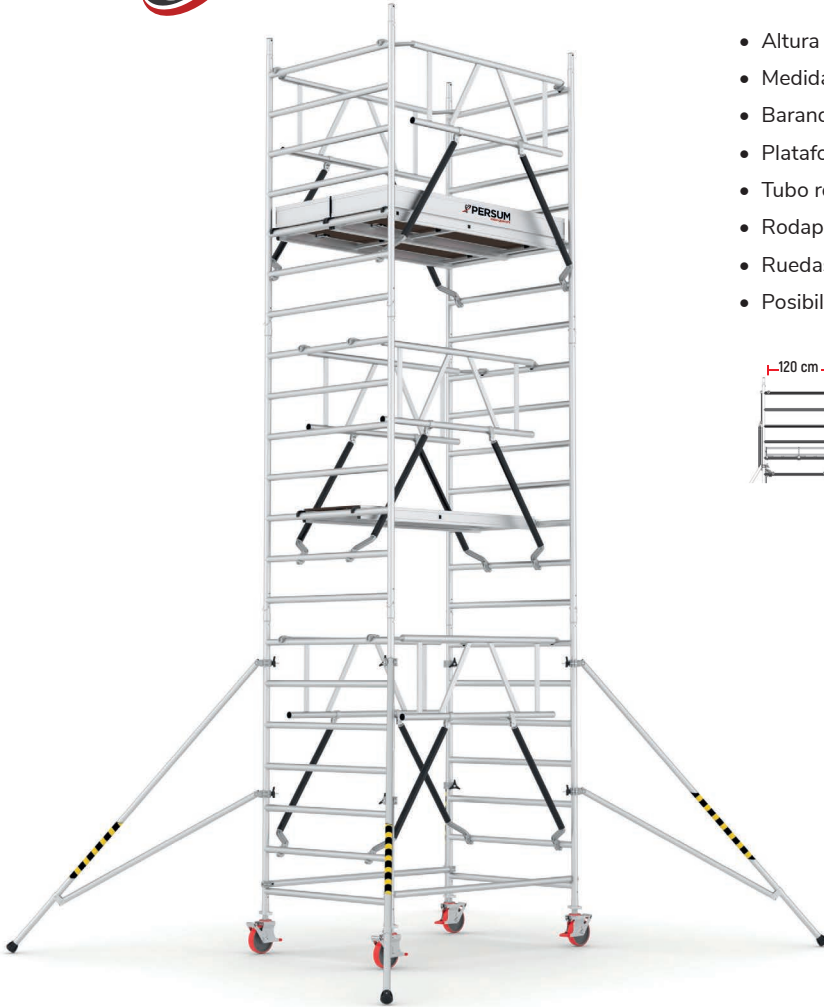
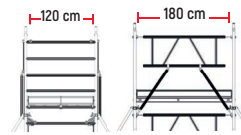

		m.	m.	m.	cm.	cm.	kg
L430	14H0452	2,3	3,73	4,3	196x135	459x398	141
L520	14H0453	3,2	4,64	5,2	196x135	459x398	148
L640	14H0454	4,4	5,84	6,4	196x135	459x398	189
L730	14H0455	5,3	6,74	7,3	196x135	459x398	196
L850	14H0456	6,5	7,94	8,5	196x135	459x398	238
L940	14H0457	7,4	8,85	9,4	196x135	459x398	245
L1060	14H0458	8,6	10,05	10,6	196x135	459x398	286
L1150	14H0459	9,5	10,96	11,5	196x135	459x398	293
L1270	14H0460	10,7	12,16	12,7	196x135	459x398	334
L1360	14H0461	11,6	13,06	13,6	196x135	459x398	342



# CONFIGURACIÓN

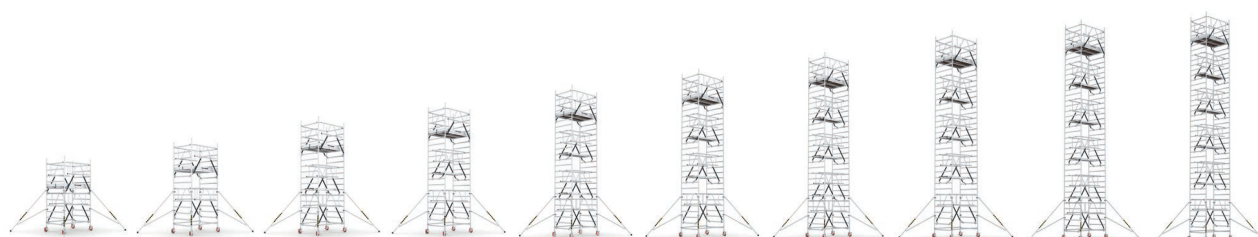
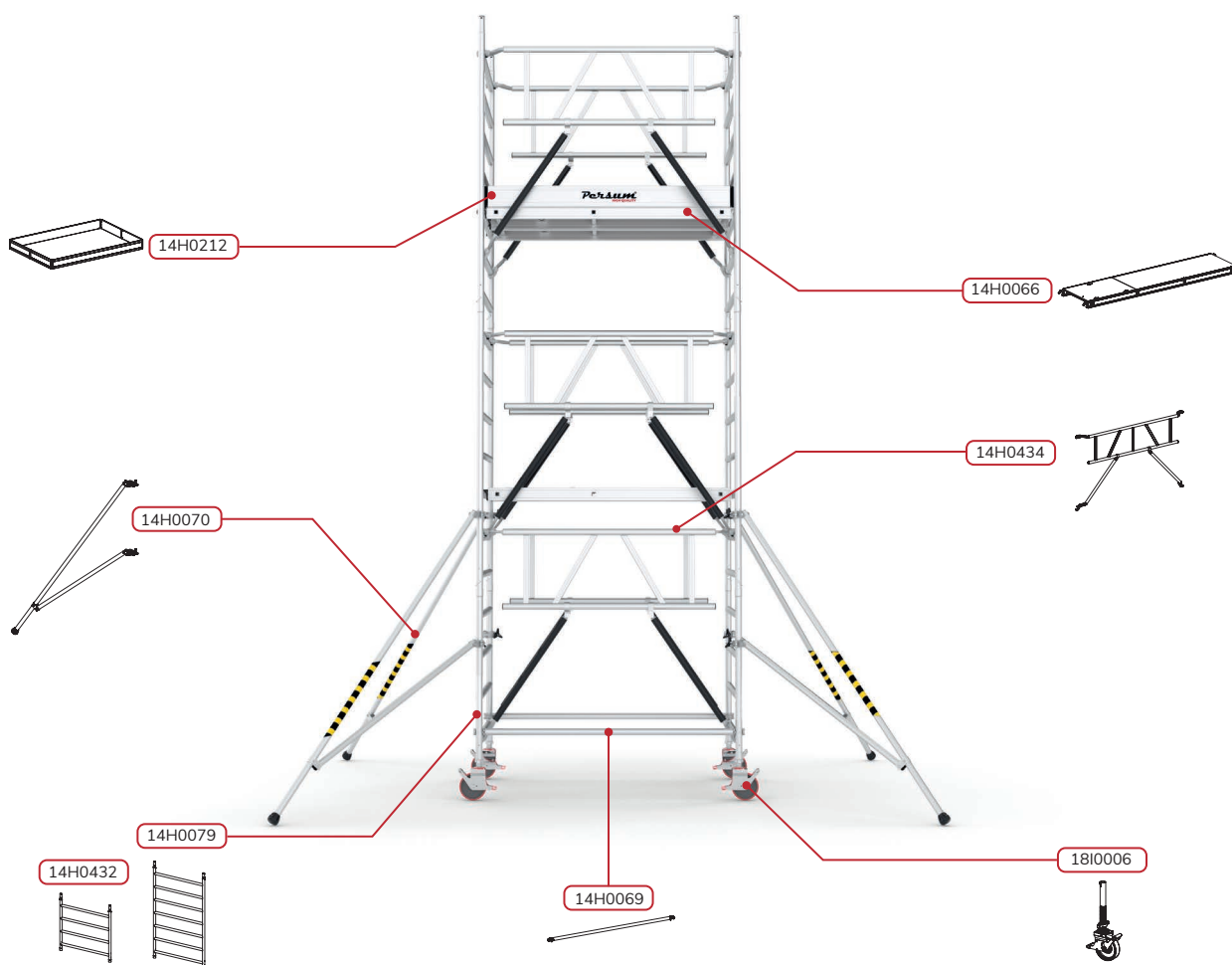

	L430	L520	L640	L730	L850	L940	L1060	L1150	L1270	L1360
18I0006	4	4	4	4	4	4	4	4	4	4
14H0432	2	-	2	-	2	-	2	-	2	-
14H0079	2	4	4	6	6	8	8	10	10	12
14H0434	4	4	6	6	8	8	10	10	12	12
14H0069	2	2	2	2	2	2	2	2	2	2
14H0070	4	4	4	4	4	4	4	4	4	4
14H0066	2	2	3	3	4	4	5	5	6	6
14H0212	1	1	1	1	1	1	1	1	1	1



# ALTEZZA TOP S240



CLASE 3

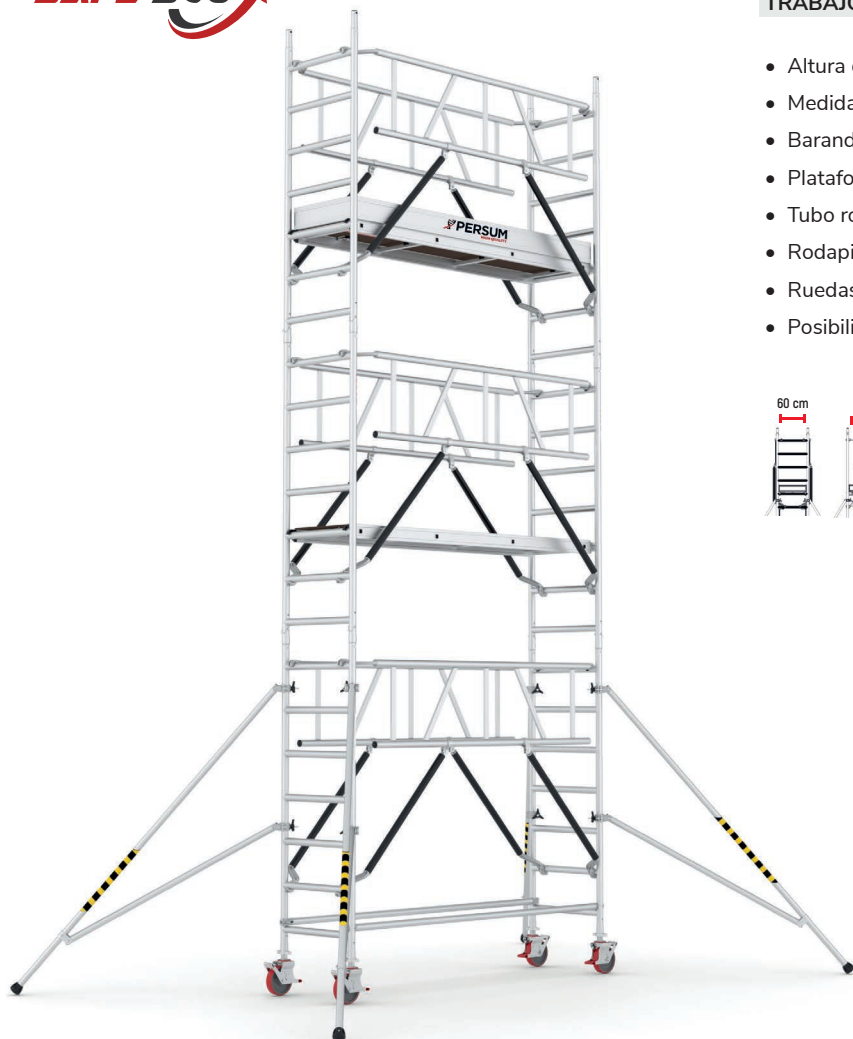

## TRABAJOS PROFESIONALES DE USO INTENSIVO

- Altura de trabajo aproximada desde 4,30 m hasta 13,60 m.
- Medidas del andamio 73x255 cm.
- Barandillas **Flash-Safe**, reduciendo el tiempo de montaje un 30%.
- Plataformas de madera **Plywood** antideslizante de 240 cm.
- Tubo robusto de 50 mm de diámetro y 1,8 mm de espesor.
- Rodapié de aluminio, rápido y fácil montaje.
- Ruedas de 200 mm de diámetro con sistema de doble freno.
- Posibilidad de trabajar dos personas.

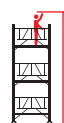
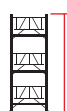
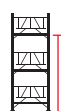
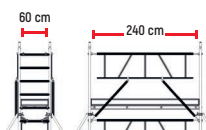

		m.	m.	m.	cm.	cm.	kg
S430	14H0462	2,3	3,73	4,3	255x73	518x336	127
S520	14H0463	3,2	4,64	5,2	255x73	518x336	132
S640	14H0464	4,4	5,84	6,4	255x73	518x336	176
S730	14H0465	5,3	6,74	7,3	255x73	518x336	182
S850	14H0466	6,5	7,94	8,5	255x73	518x336	226
S940	14H0467	7,4	8,85	9,4	255x73	518x336	231
S1060	14H0468	8,6	10,05	10,6	255x73	518x336	276
S1150	14H0469	9,5	10,96	11,5	255x73	518x336	281
S1270	14H0470	10,7	12,16	12,7	255x73	518x336	326
S1360	14H0471	11,6	13,06	13,6	255x73	518x336	331



# CONFIGURACIÓN

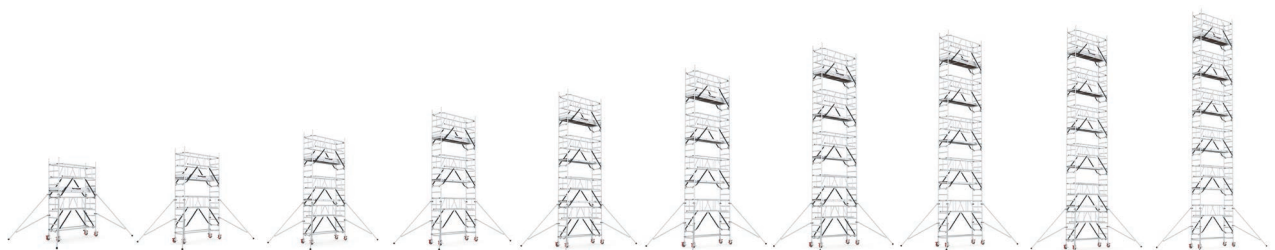
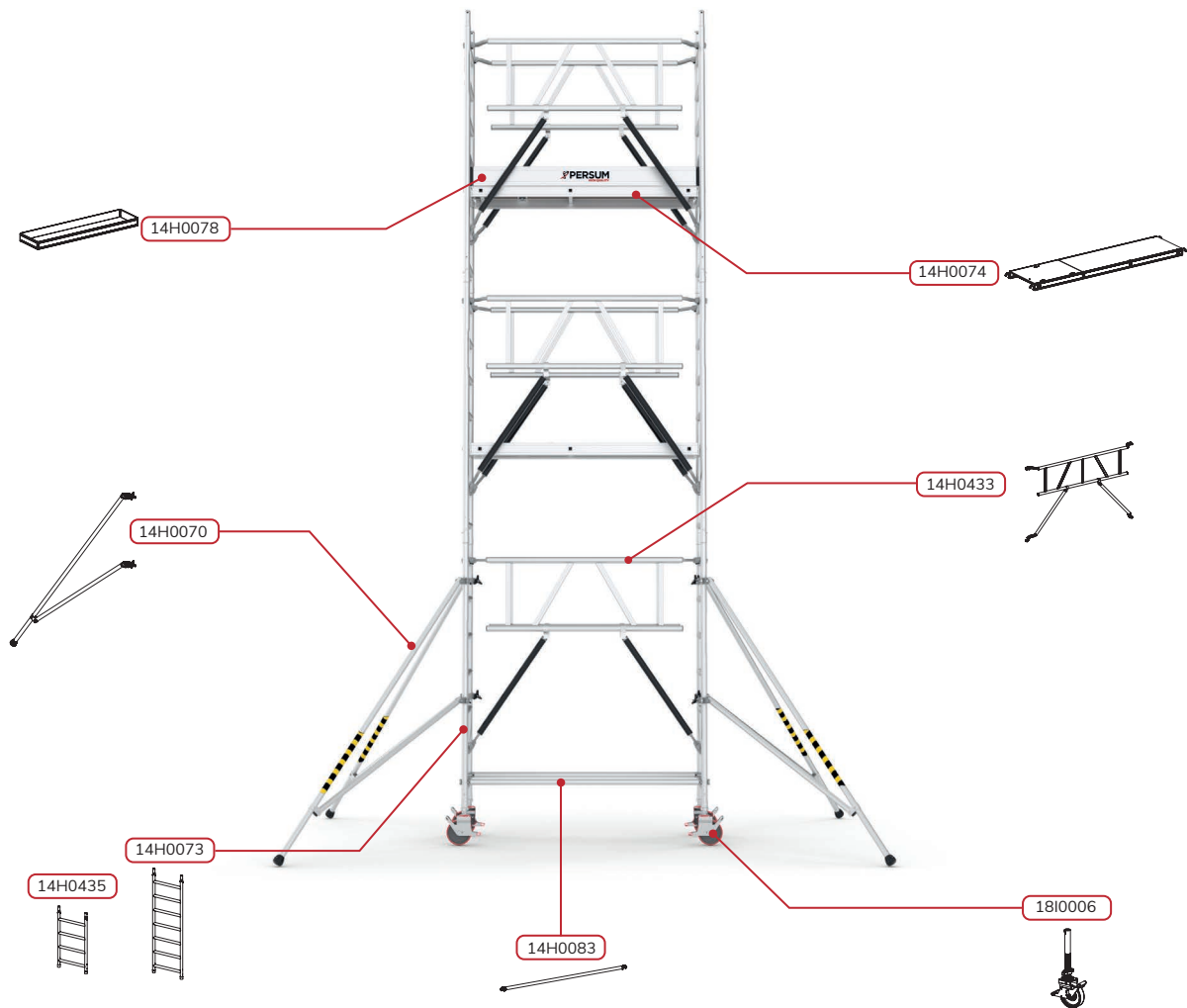

	S430	S520	S640	S730	S850	S940	S1060	S1150	S1270	S1360
18I0006	4	4	4	4	4	4	4	4	4	4
14H0435	2	-	2	-	2	-	2	-	2	-
14H0073	2	4	4	6	6	8	8	10	10	12
14H0433	4	4	6	6	8	8	10	10	12	12
14H0083	2	2	2	2	2	2	2	2	2	2
14H0070	4	4	4	4	4	4	4	4	4	4
14H0074	1	1	2	2	3	3	4	4	5	5
14H0078	1	1	1	1	1	1	1	1	1	1



# ALTEZZA TOP S 180



CLASE 3



## TRABAJOS PROFESIONALES DE USO INTENSIVO

- Altura de trabajo aproximada desde 4,30 m hasta 13,60 m.
- Medidas del andamio 73x196 cm.
- Barandillas **Flash-Safe**, reduciendo el tiempo de montaje un 30%.
- Plataformas de madera **Plywood** antideslizante de 180 cm.
- Tubo robusto de 50 mm de diámetro y 1,8 mm de espesor.
- Rodapié de aluminio, rápido y fácil montaje.
- Ruedas de 200 mm de diámetro con sistema de doble freno.
- Posibilidad de trabajar dos personas.

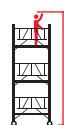
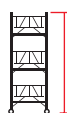
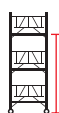
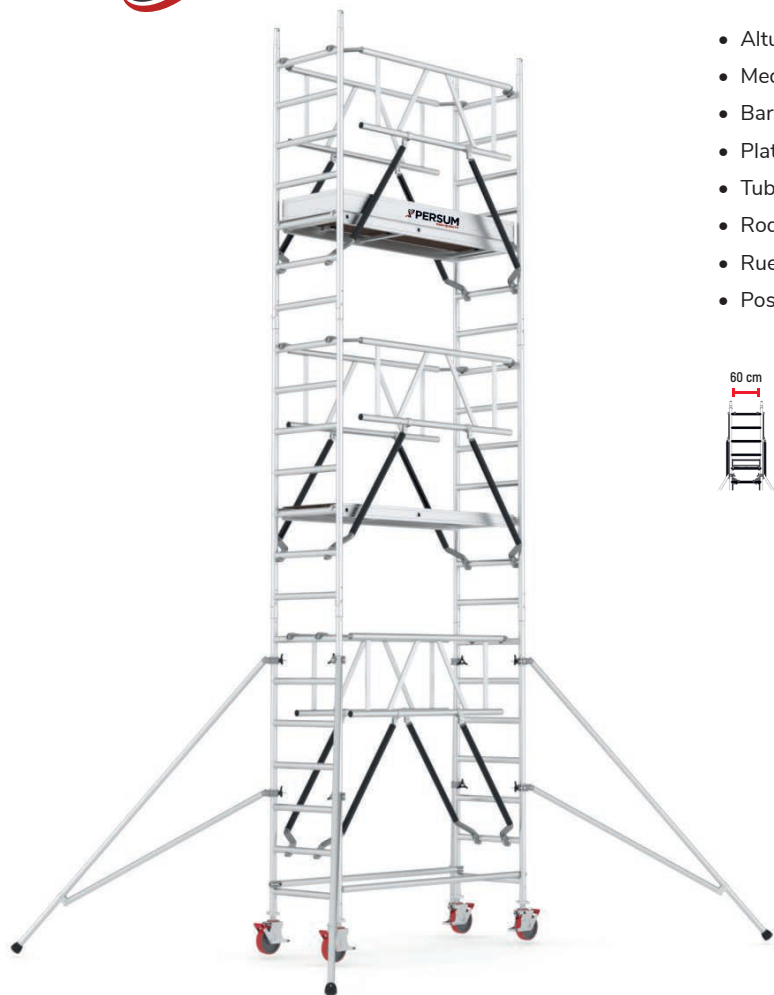
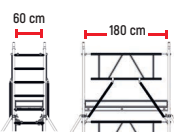

		m.	m.	m.	cm.	cm.	kg
S430	14H0472	2,3	3,73	4,3	196x73	459x336	116
S520	14H0473	3,2	4,64	5,2	196x73	459x336	121
S640	14H0474	4,4	5,84	6,4	196x73	459x336	158
S730	14H0475	5,3	6,74	7,3	196x73	459x336	164
S850	14H0476	6,5	7,94	8,5	196x73	459x336	201
S940	14H0477	7,4	8,85	9,4	196x73	459x336	206
S1060	14H0478	8,6	10,05	10,6	196x73	459x336	244
S1150	14H0479	9,5	10,96	11,5	196x73	459x336	249
S1270	14H0480	10,7	12,16	12,7	196x73	459x336	287
S1360	14H0481	11,6	13,06	13,6	196x73	459x336	292



# CONFIGURACIÓN

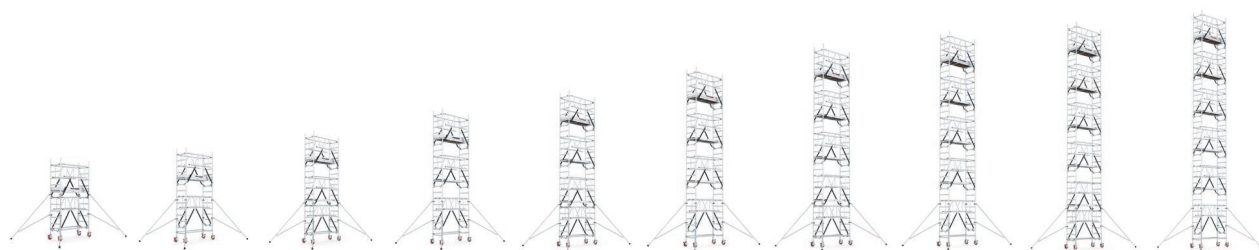
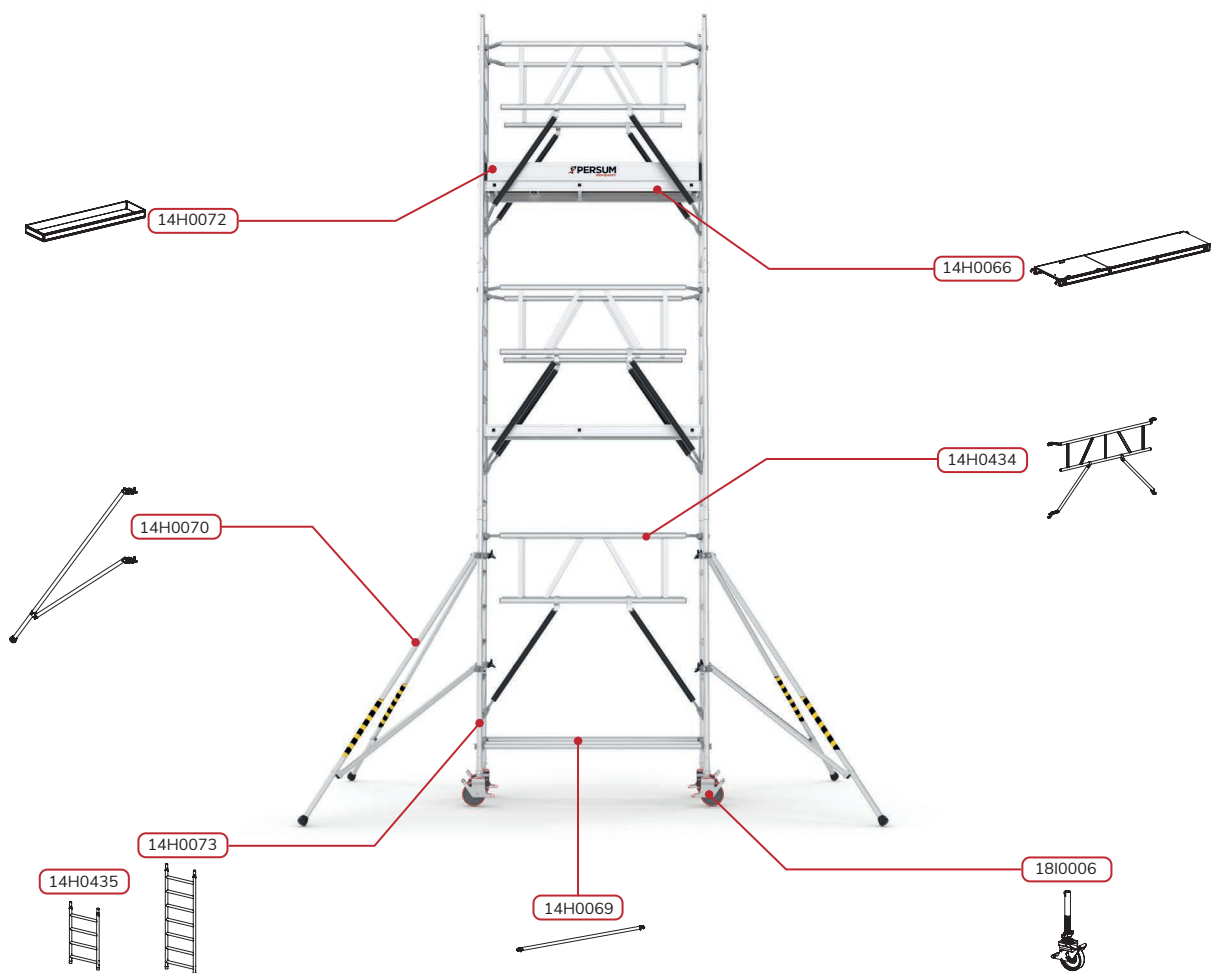

	S430	S520	S640	S730	S850	S940	S1060	S1150	S1270	S1360
18I0006	4	4	4	4	4	4	4	4	4	4
14H0435	2	-	2	-	2	-	2	-	2	-
14H0073	2	4	4	6	6	8	8	10	10	12
14H0434	4	4	6	6	8	8	10	10	12	12
14H0069	2	2	2	2	2	2	2	2	2	2
14H0070	4	4	4	4	4	4	4	4	4	4
14H0066	1	1	2	2	3	3	4	4	5	5
14H0072	1	1	1	1	1	1	1	1	1	1

